



ZODIAC CH 650 Series

Parts are labeled for easy identification with a part number and description:

Part number example:
6T4-4 Vertical Tail Spar

- 6** - Zodiac CH 650 model
- T** - Rudder section of the Aircraft drawings.
- 4** - Page 4 of the Rudder drawings.
- 4** - Part 4 on page 4.

Kit parts that make up the rudder skeleton.

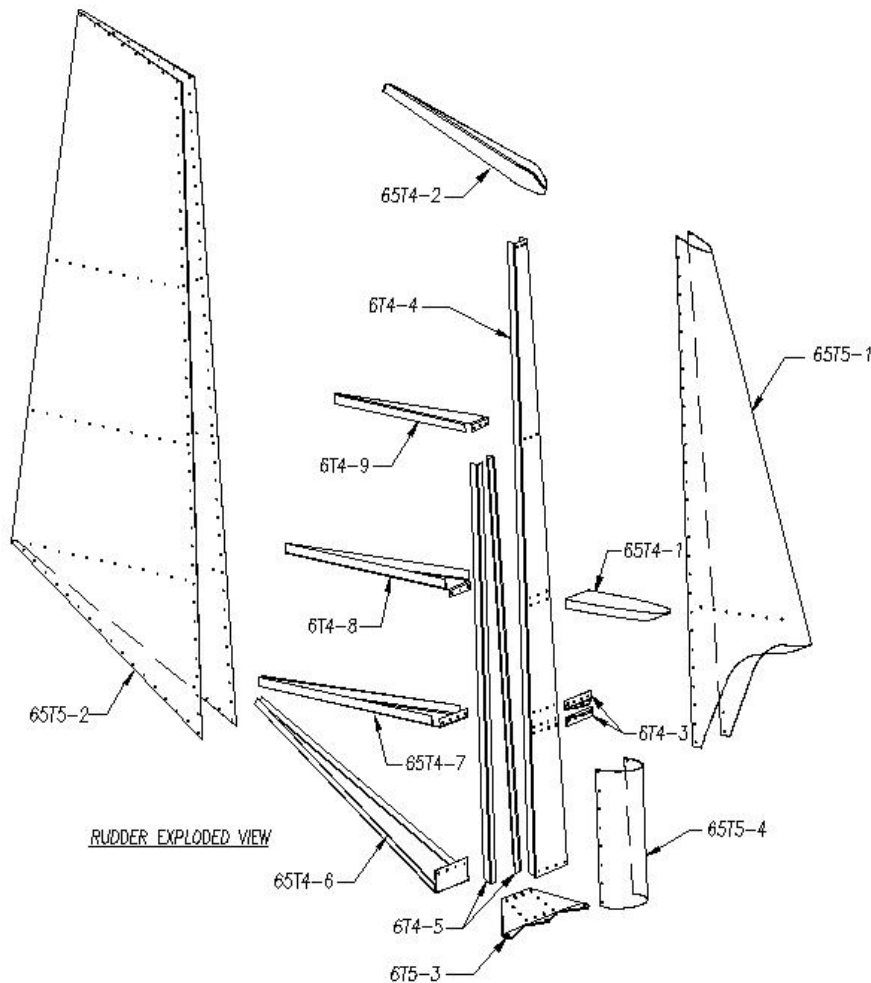

In addition to this photo assembly guide, also refer to drawings 6-T-4 and 6-T-5 for technical information.

Exploded view of the rudder assembly

This manual has been prepared for assembly of the Rudder Starter Kit supplied with the predrilled Rudder Spar and Rear Skin.

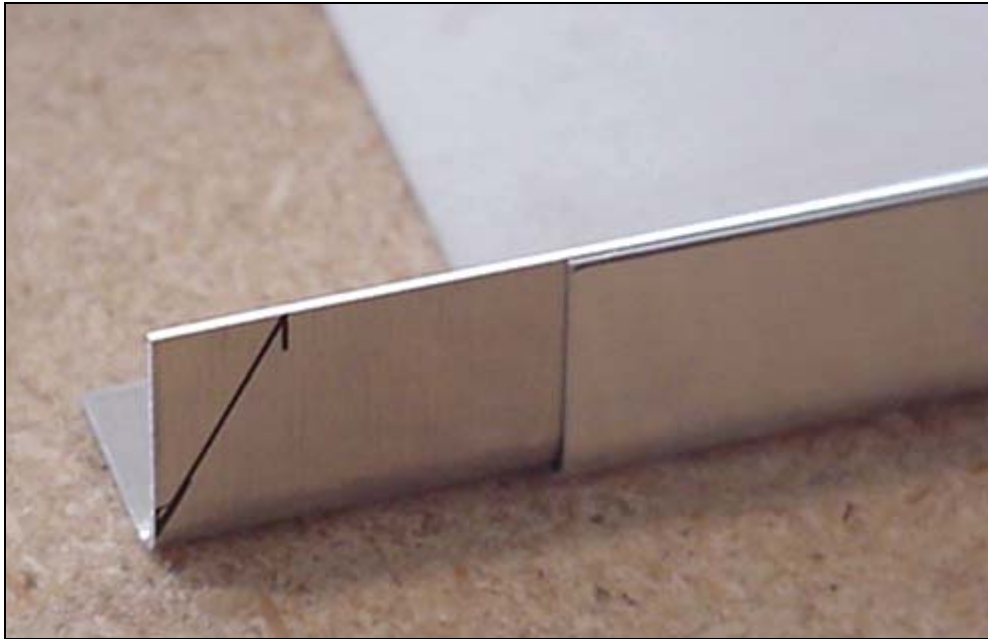

6T4-5 Doubler Angle

Note: The spar flange should not be flush with the edge of the doubler.

Do not use a scribe or a pencil to mark.

Mark the bottom side corner on the side flange of the doubler. Measure 12mm from the end and mark a line to the bottom corner.



To choose between the red or green snips: The bottom jaw is positioned under the cutoff piece. The bottom jaw will cause the material to curl, let this happen to the piece that is removed.

Trim the bottom corners of the doubler angle.

It is a good idea to practice on piece of scrap material to get a feel for the snips first.

Left Photo: Green handled snips.



Handi-Clamp
P/N: TP640HC

The doublers extend 30mm past the bottom of the Spar.

Measure up 30mm from the bottom of the doubler and mark a reference line along the edge of the doubler.



Install a rubber stop on the drill bit. (small piece of rubber hose sliced in half)

Clamp the doublers in place.



Edge Distance = e

This is the distance from the center of a hole to the edge of the material.

In general $e = 3 \times D$

D is the diameter of the hole.

For the A4 and A5 rivets
e = 10mm

Drill Sizes:

A3 rivet/pilot hole: #40

A4 rivet: #30

A5 rivet: #20

Drill and cleco every other hole. Finish drilling without adding more clecos.



EDGE MARKER BLOCK:

P/N: 6352

Tighten the screw on the gauge arm when the marker is on the reference line. Pull the marker to strike a line.



First mark a reference line along the edge of a practice piece of material.

Edge distance = 9mm



Free hand method: use your finger as a gauge to hold the marker equal distance to the edge.

Mark the flange rivet line on all 3 flanges: front and sides. Rear ribs 2, 3, 4 and on the nose rib.



The pre-drilled holes in the spar web are measured from the bottom end of the doublers. Refer to drawing 6-T-5 for the rib locations.

Position the rib on the back side of the spar.



Clamp the rib to the spar.
Use the toggle clamps.

Adjust the position of the rib until the rivet line on the rib flange is visible through the pre-drilled holes in the spar.

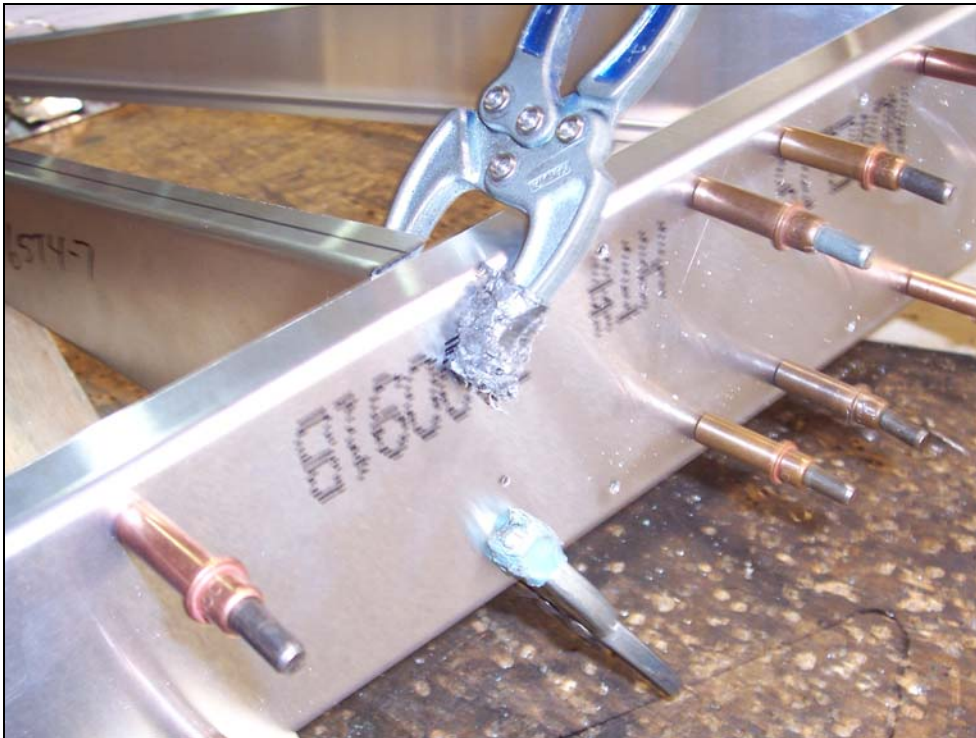

View of rib flange.

Position the spar on its side (raised on 2x4 blocks to keep the clamps off the workbench).
Drill and cleco the two middle holes. Remove the clamps and drill the two outer holes.



Rear rib #3, the spar flange points down, the side flanges point up.

Refer to drawing 6-T-5 for the orientation. The hidden line (dash line) represents the web (flat section of rib).

Drill and Cleco rear ribs 3 and 4.

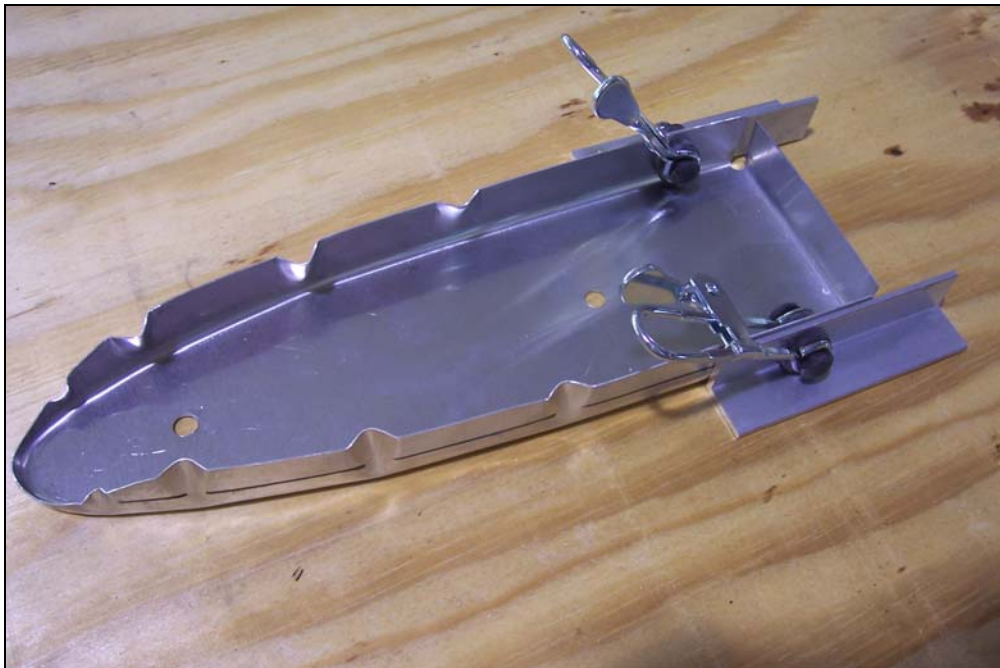

EXTRUSIONS.
Upper bearing 6T4-3
Qty: 2

65T4-1 Nose Rib

To center the nose rib on spar: Clamp the extrusions to the rib flange. (On the clamp, push the handle forwards).

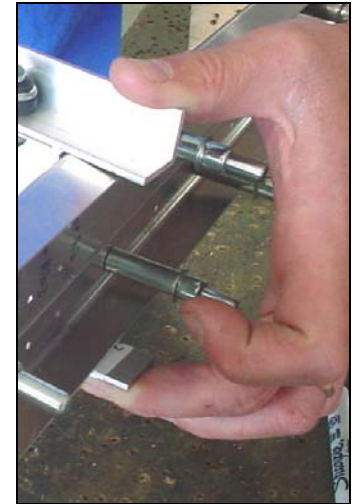
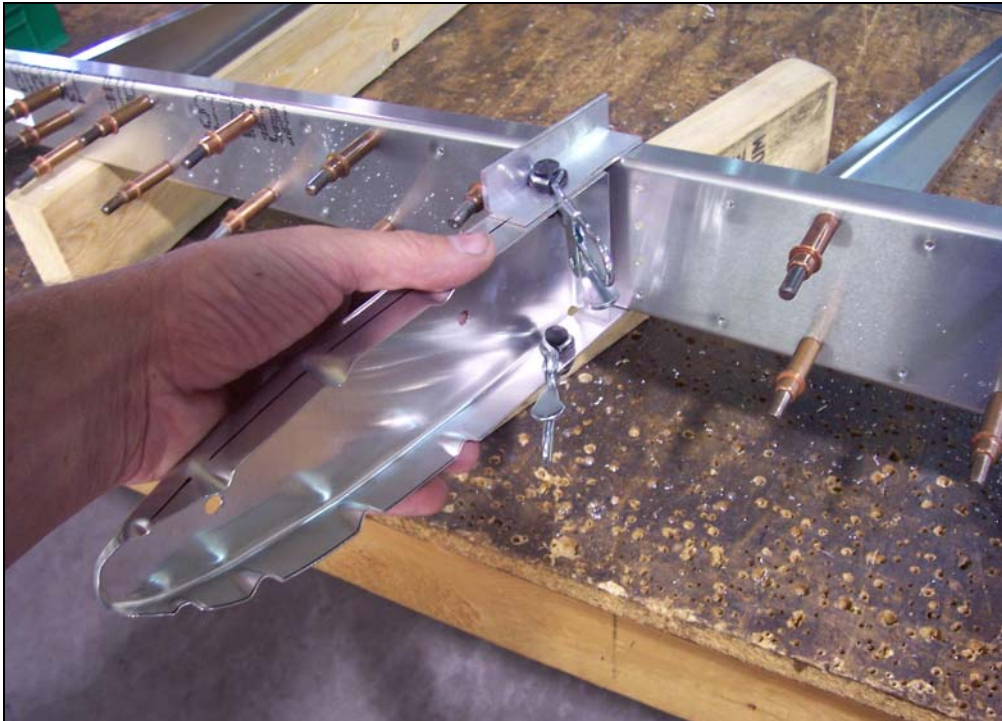

Squeeze the ends of the extrusions together to center the rib on the spar.

ORIENTATION: flange points down.

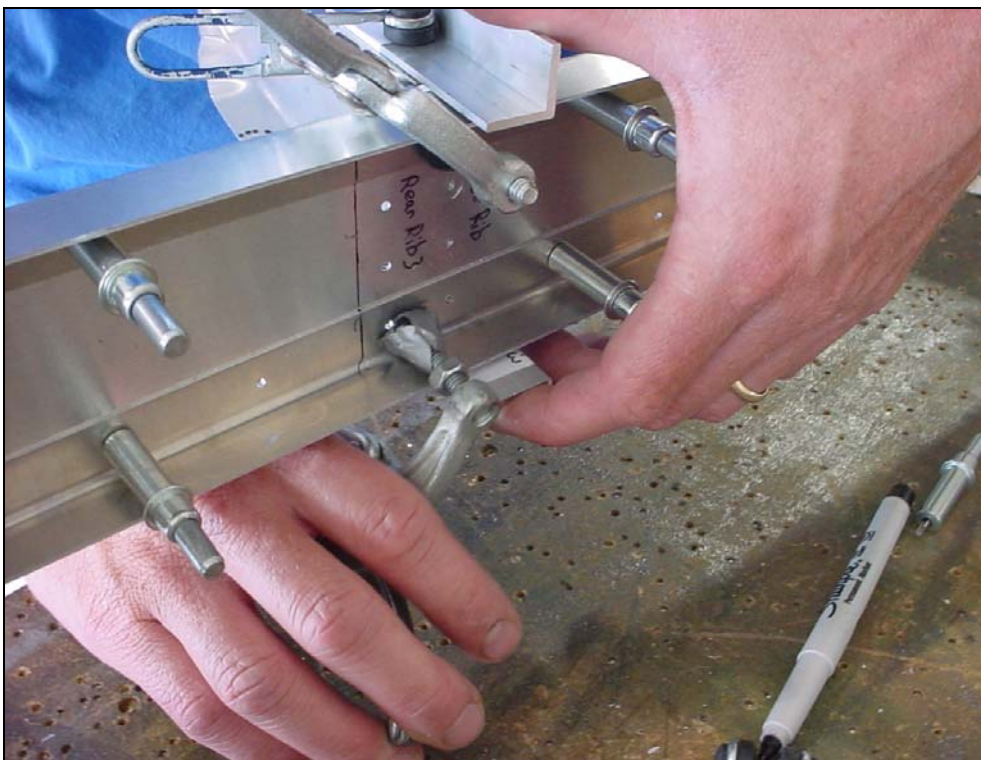

Clamp the rib to the spar.

Check the rivet line on the rib flange is visible through the pilot holes.

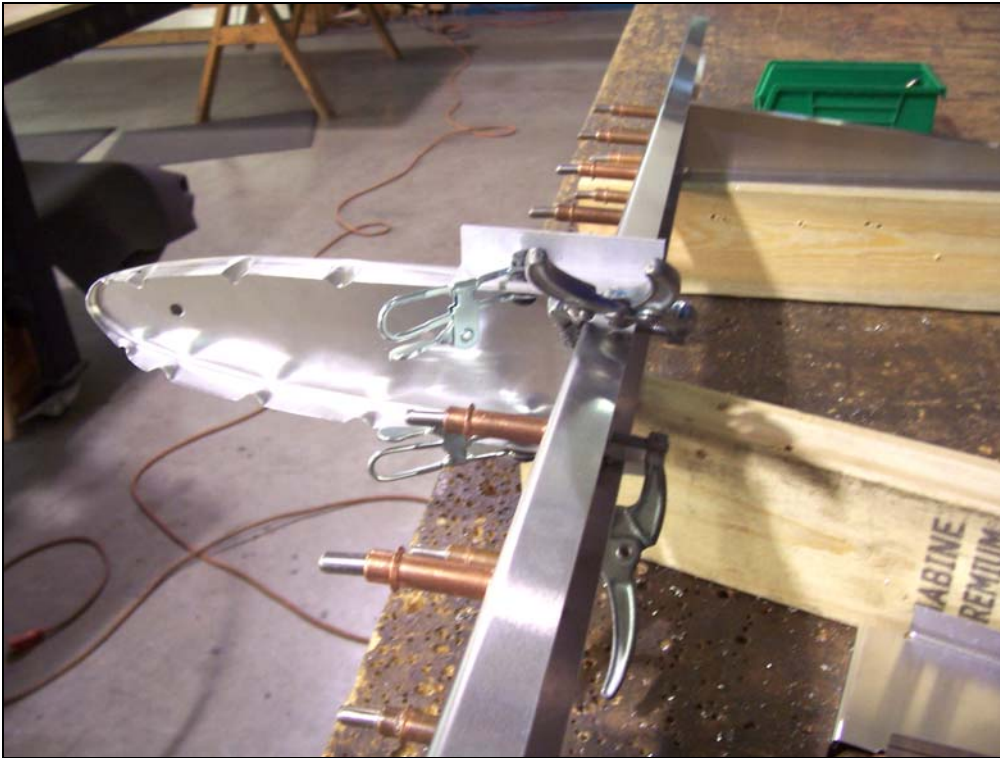

65T4-1
Drill and Cleco the nose rib to the spar.

Re-install RR#3

Remove rib #3 to drill the nose rib.



An alternative method is to use a large drill bit, and to give each hole a quarter turn. Remember to deburr both sides of every hole.

Deburr the holes and rough edges, file and radius any sharp corners. Cleco the Doublers and Ribs to the Spar.
Burs in aluminum are very small; most can be knocked off with a flat file: lay the file flat on the rivet line and push it forwards.



Special machined riveter nose piece



Hand riveter

The diameter of the machined nose piece on the riveter is the same diameter as the rivet head. Differently sized nose pieces are required for the A4 and A5 rivets – don't pull A4 rivets with the A5 nose piece.

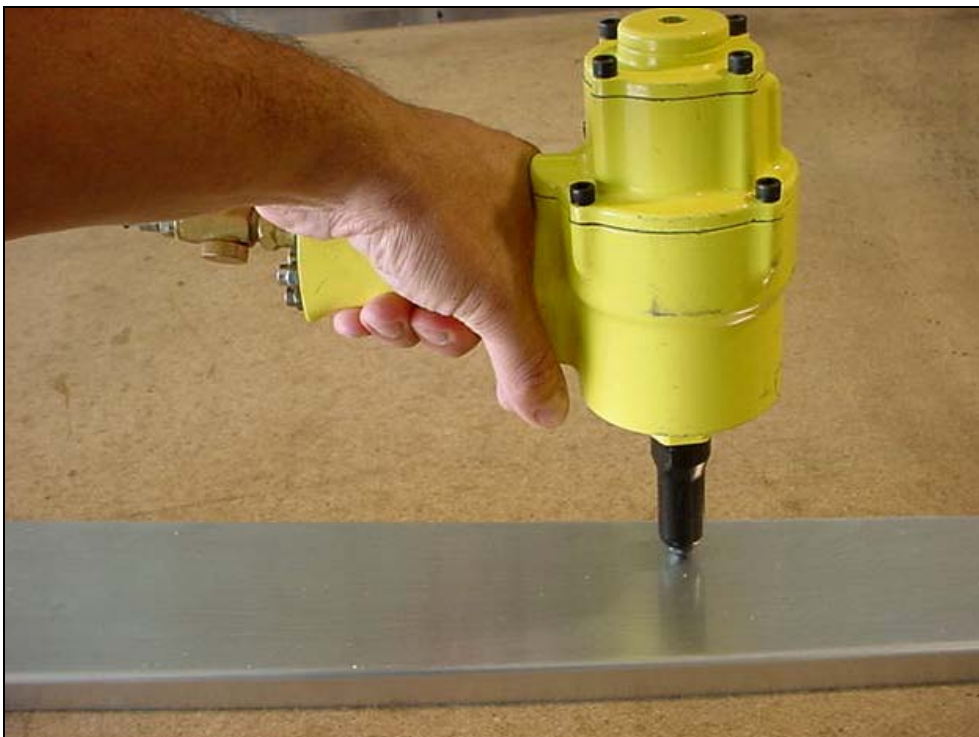

A4 Rivet (Avex blind rivet)



IMPORTANT: When pulling rivets, keep the riveter square (perpendicular) to the work piece.



The Rudder Skeleton
(left)

Note: at the factory workshops held by Zenith Aircraft Co. the parts have already been primed for corrosion protection.



CHECK: No gap should exist between edge of rivet head and sheet-metal.

Set the rivet head on the front side of the spar (it is also acceptable to have rivets pull from the back side) Tip rib; rivet head is set on the top side (outside). (The photo above shows rear rib #1 installed, this is done later.)

Note: Don't rivet the Spar and Doubler below Rear Rib #2.